

TAI-SAW TECHNOLOGY CO., LTD.

No. 3, Industrial 2nd Rd., Ping-Chen Industrial District,
Taoyuan, 324, Taiwan, R.O.C.

TEL: 886-3-4690038 FAX: 886-3-4697532

E-mail: tstsales@mail.taisaw.com Web: www.taisaw.com

Product Specifications Approval Sheet

Issued Date: May, 31, 2013

Product Name: SAW Resonator 315.500 MHz SMD 3.8X3.8 mm

TST Parts No.: TC0192B

Customer Parts No.: _____

Company: _____
Division: _____
Approved by : _____
Date: _____

Checked by: Justin Wu *Justin*

Approval by: Bob Chau *Bob Chau*

Date: 2013/05/31

1. Customer signed back is required before TST can proceed with sample build and receive orders.
2. Orders received without customer signed back will be regarded as agreement on the specifications.
3. Any specifications changes must be approved upon by both parties and a new revision of specifications shall be released to reflect the changes.



TAI-SAW TECHNOLOGY CO., LTD.

No. 3, Industrial 2nd Rd., Ping-Chen Industrial District,
Taoyuan, 324, Taiwan, R.O.C.

TEL: 886-3-4690038 FAX: 886-3-4697532

E-mail: tstsales@mail.taisaw.com Web: www.taisaw.com

SAW Resonator 315.500 MHz

MODEL NO.: TC0192B

REV. NO.:1

A. FEATURES:

1. 1-Port Resonator.

B. MAXIMUM RATING:

RoHS Compliant
Lead free
Lead-free soldering

1. Input Power Level: +0 dBm

2. DC voltage: 12 V D.C

3. Operating Temperature: -40°C to +85°C

4. Storage Temperature: -40°C to +85°C

Electrostatic Sensitive Device (ESD)

C. ELECTRICAL CHARACTERISTICS:

Characteristic	Units	Minimum	Typical	Maximum
Center frequency Fr	MHz	315.425	315.500	315.575
Insertion Loss IL	dB	-	1.6	2.1
Equivalent Elements				
Motional capacitance C1	fF	-	3.18	-
Motional inductance L1	μH	-	80.36	-
Motional resistance R1	Ohm	-	24.50	-
Parallel capacitance Co	pF	-	4.76	-
Temp.coeff.	ppm/c*2	-	0.032	-
Turnover To	deg.C	-	25	-
Package size		SMD 3.8X3.8X1.4mm		

D. EQUIVIRENT CIRCUIT:

One-Port Resonator:

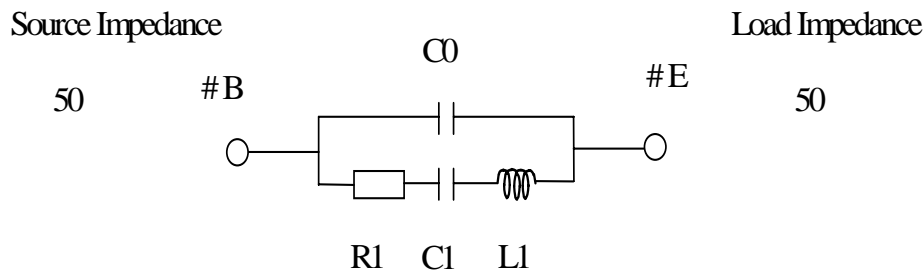

D. OUTLINE DRAWING:

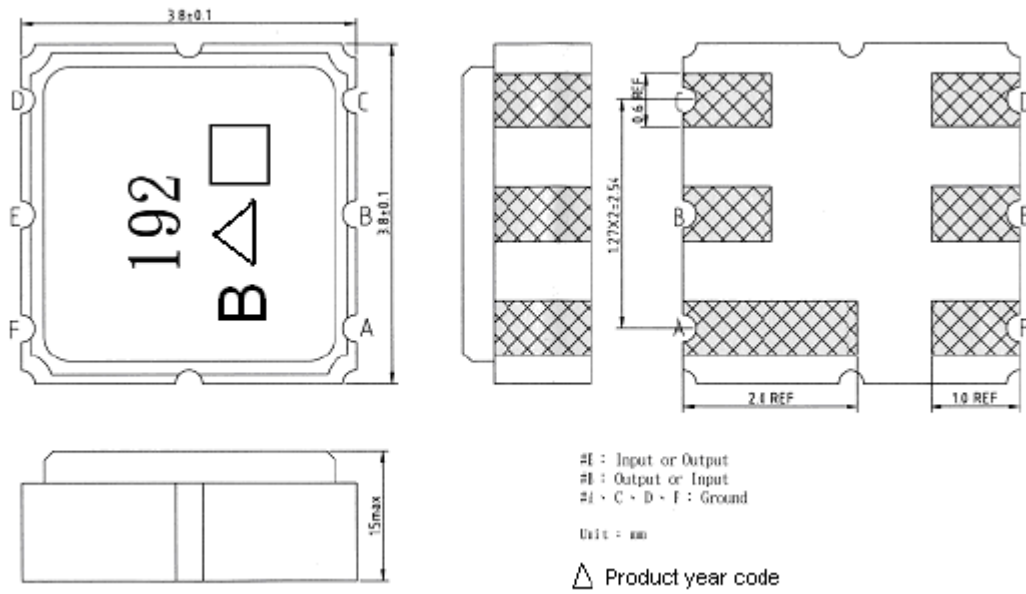

△ Year code : See the table

Year	2011 2013	2012 2014
Year code	C	c

□ Data code : See the table

WK01	WK02	WK03	WK04	WK05	WK06	WK07	WK08	WK09	WK10	WK11	WK12	WK13
A	B	C	D	E	F	G	H	I	J	K	L	M
WK14	WK15	WK16	WK17	WK18	WK19	WK20	WK21	WK22	WK23	WK24	WK25	WK26
N	O	P	Q	R	S	T	U	V	W	X	Y	Z
WK27	WK28	WK29	WK30	WK31	WK32	WK33	WK34	WK35	WK36	WK37	WK38	WK39
a	b	c	d	e	f	g	h	i	j	k	l	m
WK40	WK41	WK42	WK43	WK44	WK45	WK46	WK47	WK48	WK49	WK50	WK51	WK52
n	o	p	q	r	s	t	u	v	w	x	y	z

F.FREQUENCY CHARACTERISTICS:

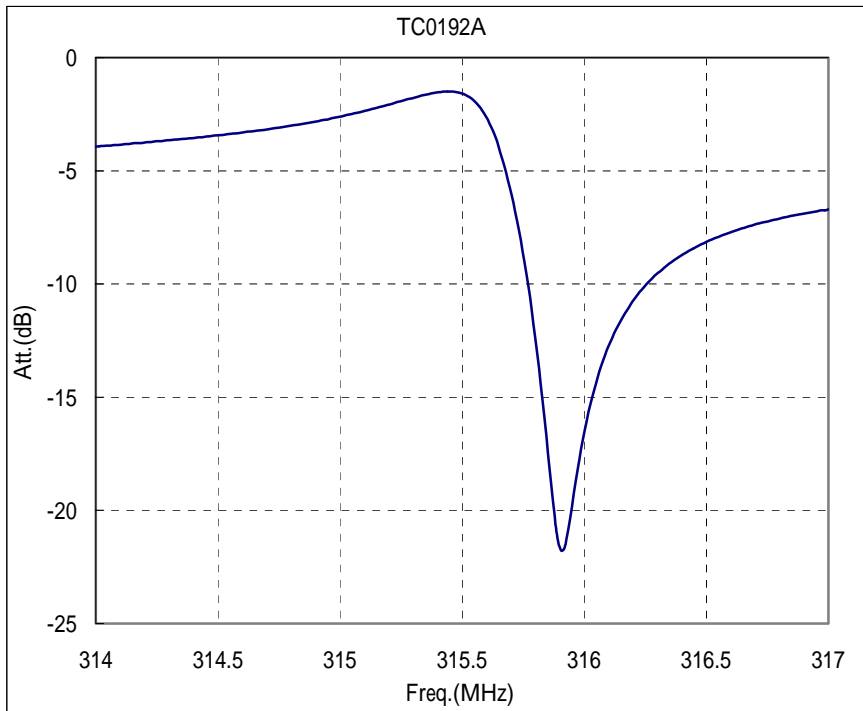

G. TEST CIRCUIT:

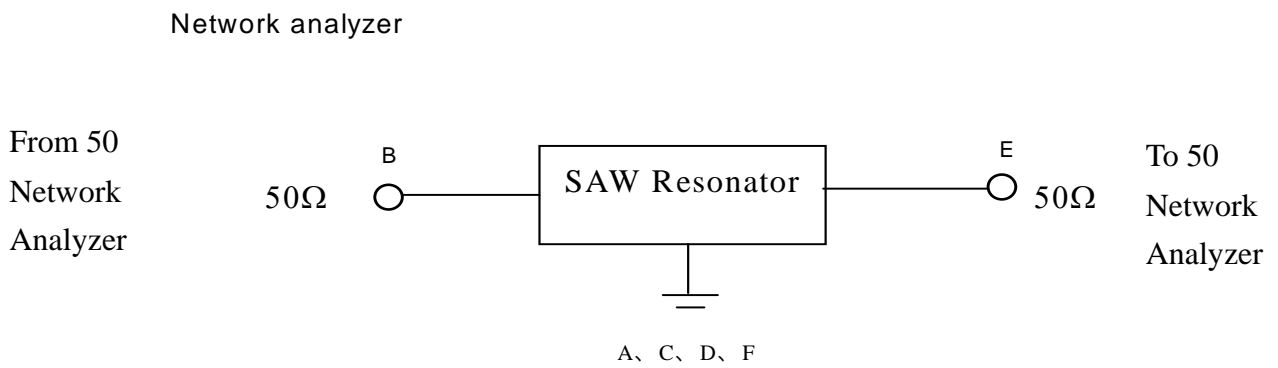

H. PACKING:

1. REEL DIMENSION

(Please refer to FR-75D10 for packing quantity)

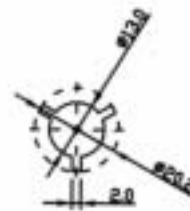
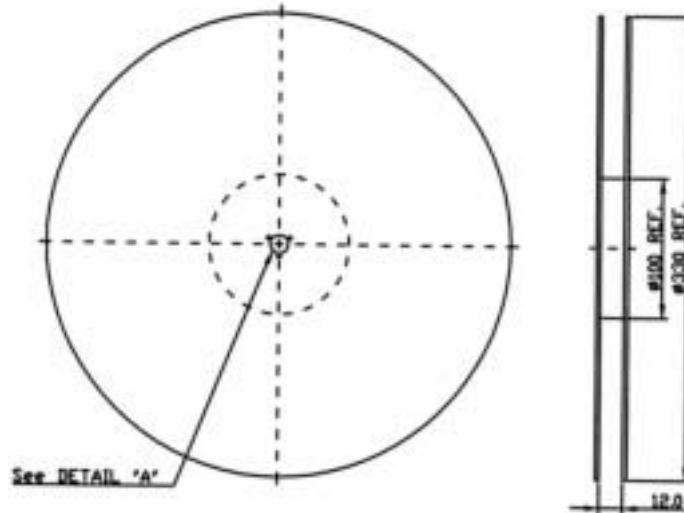

2. TAPE DIMENSION

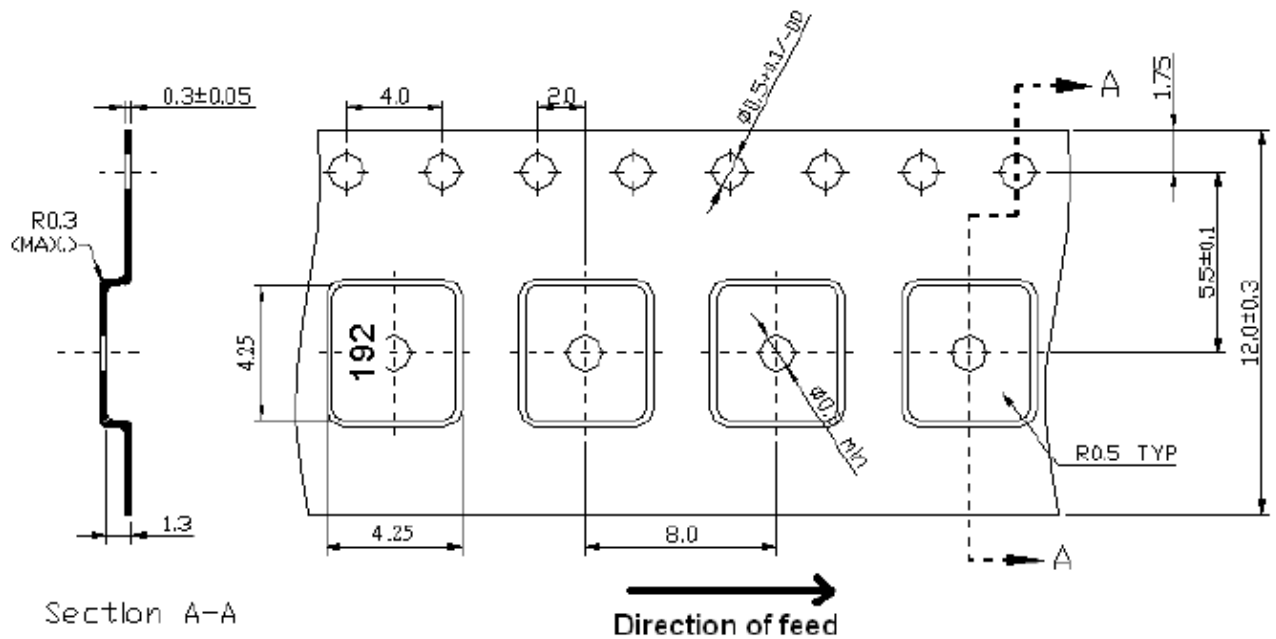

J. RECOMMENDED REFLOW PROFILE:

